



www.new-nb.com

F150 Gas-Strut Monitor Wall Mount



Screen Size

17"-35"



Capacity

4.4-22lbs (2-10kg)



VESA

75x75, 100x100mm



Lift

7.6" (195mm)

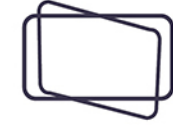

Swivel angles

180°



Rotation

360°



Tilt angles

+85°/ -30°

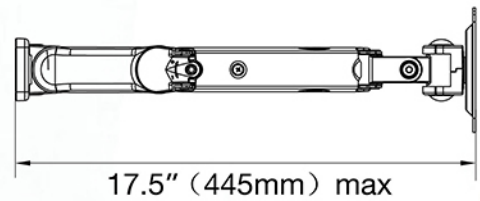

17.5" (445mm) max

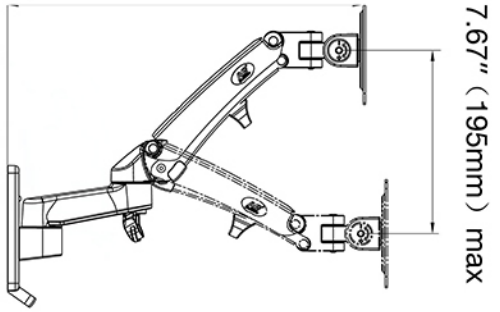

7.67" (195mm) max

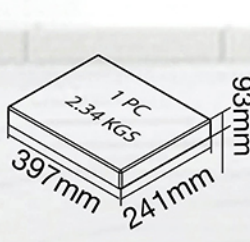
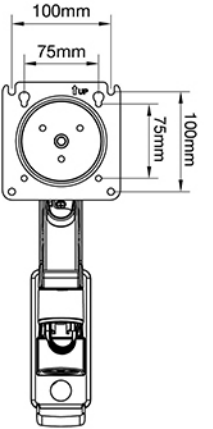

1 PC
2.34 KGS

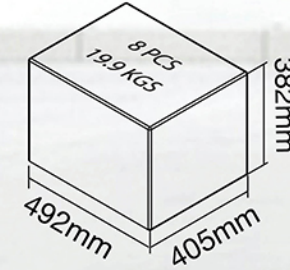

8 PCS
19.9 KGS

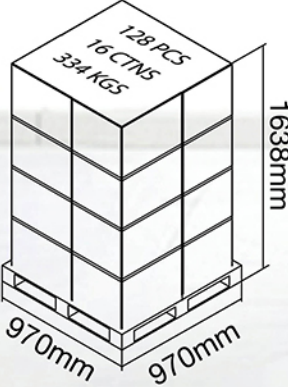

128 PCS
16 CTNS
334 KGS

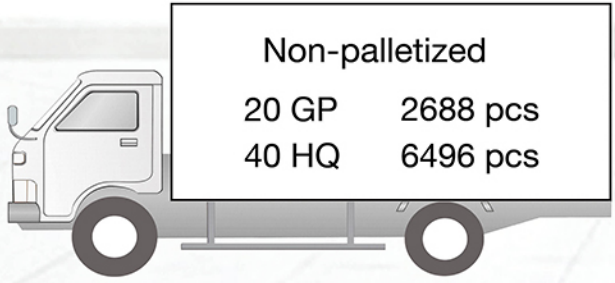

Non-palletized
20 GP 2688 pcs
40 HQ 6496 pcs

